

# Comparing Storage Devices

In this chapter, you'll learn about the different types of storage devices, including hard drives, solid state drives, optical drives, and fault tolerant arrays. Many different types of interfaces are currently used to connect drives, and it's important to know what is available and how to connect them. This chapter covers the hardware elements of hard drives, and in Chapter 16, "Understanding Disks and File Systems," you'll build on this knowledge to configure and troubleshoot disks.

## Exam 220-801 objectives in this chapter:

- 1.5 Install and configure storage devices and use appropriate media.
  - Optical drives
    - CD-ROM
    - DVD-ROM
    - Blu-Ray
  - Combo drives and burners
    - CD-RW
    - DVD-RW
    - Dual Layer DVD-RW
    - BD-R
    - BD-RE
  - Connection types
    - External
      - USB
      - Firewire
      - eSATA
      - Ethernet

- Internal SATA, IDE and SCSI
  - IDE configuration and setup (Master, Slave, Cable Select)
  - SCSI IDs (0 – 15)
- Hot swappable drives
- Hard drives
  - Magnetic
  - 5400 rpm
  - 7200 rpm
  - 10,000 rpm
  - 15,000 rpm
- Solid state/flash drives
  - Compact flash
  - SD
  - Micro-SD
  - Mini-SD
  - xD
  - SSD
- RAID types
  - 0
  - 1
  - 5
  - 10
- Floppy drive
- Tape drive
- Media capacity
  - CD
  - CD-RW
  - DVD-RW
  - DVD
  - Blu-Ray
  - Tape
  - Floppy
  - DL DVD

- 1.7 Compare and contrast various connection interfaces and explain their purpose.
  - Physical connections
    - SATA1 vs. SATA2 vs. SATA3, eSATA, IDE speeds
- 1.11 Identify connector types and associated cables.
  - Device connectors and pin arrangements
    - SATA
    - eSATA
    - PATA
      - IDE
      - EIDE
    - SCSI
  - Device cable types
    - SATA
    - eSATA
    - IDE
    - EIDE
    - Floppy
    - SCSI
      - 68pin vs. 50pin vs. 25pin

### **Exam 220-802 objectives in this chapter:**

- 4.3 Given a scenario, troubleshoot hard drives and RAID arrays with appropriate tools.
  - Common symptoms
    - Read/write failure
    - Slow performance
    - Loud clicking noise
    - Failure to boot
    - Drive not recognized
    - OS not found
    - RAID not found
    - RAID stops working
    - BSOD
  - Tools
    - Screwdriver
    - External enclosures

# Hard Drives



The *hard disk drive (HDD)* is the primary long-term storage device used in personal computers. A hard drive includes multiple *platters* that spin as fast as 15,000 revolutions per minute (rpm). These platters are covered with ferromagnetic material, and data can be written to the drive by magnetizing that material. The hard drive is not volatile. That is, even without power, data remains stored on the drive.

Figure 4-1 shows an open hard drive, with the physical components listed on the left and the logical components on the right.

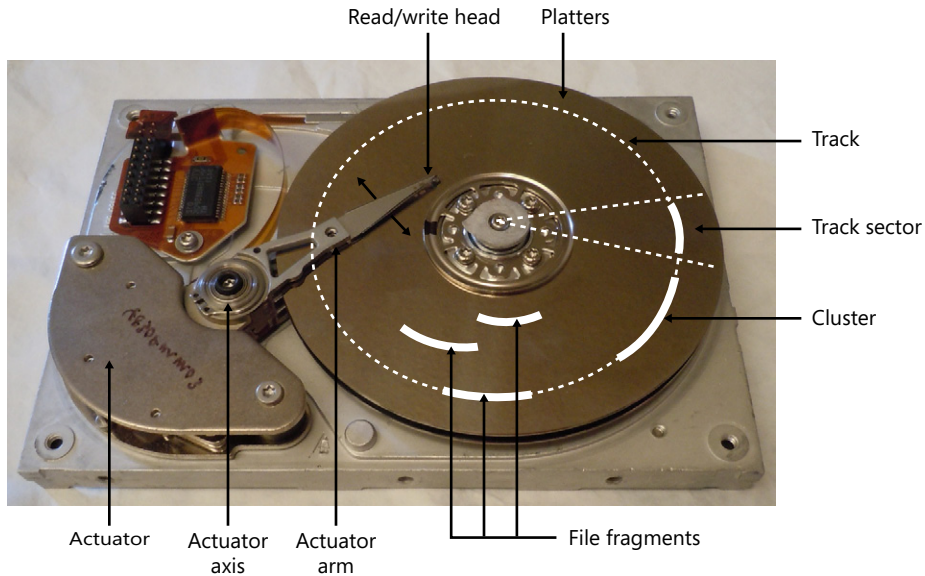

**FIGURE 4-1** Looking inside a hard drive.

## **IMPORTANT** DON'T OPEN HARD DRIVES IF YOU WANT TO USE THEM AGAIN

The heads are riding on a very thin pocket of air hundreds of times smaller than a human hair. They are sealed to prevent contaminants from getting inside, but if you open a hard drive and then try to use it, the heads can crash on these contaminants, making the drive useless.

### ■ **Physical components:**

- **Platters.** Hard drives have multiple spinning platters, and each platter can be written to on both sides.
- **Read/write head.** A hard drive will have one read/write head for each platter side. This drive has two platters and four read/write heads.
- **Actuator.** The *actuator* controls the movement of the arm.

- **Actuator arm and axis.** The actuator arm is moved back and forth by pivoting around the actuator axis. This positions the read/write head on different areas of the platter.
- **Logical components:**
  - **Tracks.** Each platter is logically divided into multiple tracks, which are circular areas on the disk. When the head is positioned over a *track*, it can read or write data on the track as the platter spins.
  - **Sectors.** Tracks are logically separated into track sectors. A *sector* can be between 512 bytes and 2 KB in size.
  - **Clusters.** A *cluster* is a group of multiple sectors. Clusters are also known as allocation units and are the smallest element of a drive to which an operating system can write.

**NOTE HOW MANY SECTORS ARE ON A 1-TB DRIVE?**

A 1-TB hard drive using 2-KB sectors would have about 500 million track sectors. The tracks, track sectors, and clusters shown in Figure 4-1 aren't shown in actual size, but the figure does accurately illustrate their relationships to each other.

- **Files.** Files are written to clusters. If the file is bigger than a single cluster, the file is written to multiple clusters. Ideally, a file will be written to clusters that are next to each other, or *contiguous clusters*. However, if other data is already written on an adjoining cluster, the file is fragmented and written to another available cluster.

During normal hard disk operation, the platters spin at a constant rate. When data needs to be read or written, the actuator moves the actuator arm to position the head over a specific track. It waits for the target cluster to arrive under the head, and then it reads or writes the data. When you think about how fast the platters are spinning, you realize how amazing the technology has become.

## Hard Drive Characteristics

It's relatively common to replace or add a hard drive to a system. For example, many people store enough data on the original drive that came with their computer that they fill up the drive. They can either buy a new computer or buy an additional hard drive, and the additional hard drive is much cheaper.

If you're shopping for a new hard drive, you'll want to remember the following important considerations:

- **Capacity or Size.** The size of the drive is listed as GB or TB—for example, 750 GB or 1 TB. Bigger drives hold more data but are more expensive.
- **Interface.** You can connect a drive internally or externally. Later sections in this chapter cover the different choices.

- **Rotational speed.** This is stated as rpm, and higher speeds generally result in a faster drive.

## Hard Drive Speeds

The rotational speed of the drive helps determine how quick it will be overall. Common speeds are 5,400, 7,200, 10,000, and 15,000 rpm. Drives with 7,200 rpm are used in standard desktop computers.



Other factors also contribute to the speed. For example, *seek time* refers to the average amount of time it takes to move the read/write head from one track to another track, and lower seek times are better. If you find two drives of the same size with the same rpm speed but one is significantly cheaper, it might be due to a higher seek time, resulting in overall slower performance.

The interface can also limit the speed. Imagine a drive spinning at 15,000 rpm with a low seek time. It can read and write data to and from the hard drive, but it is limited as to how much data can actually be transferred between the hard drive and other computer components. The following sections describe common interfaces.

## IDE/EIDE/PATA Drives

---

Hard drive interfaces have gone through several changes and improvements over the years. Even though you won't see many of the older versions, if you understand a little about them, it makes it easier to understand current versions. Also, many of the older versions are mentioned in the CompTIA A+ objectives. As a quick introduction, the following list provides a short history:



- **Integrated Drive Electronics (IDE).** These appeared in the 1980s and included drive controller electronics on the drive.
- **Advanced Technology Attachment (ATA).** *IDE* was standardized as *ATA* and later became known as *ATA-1*. The maximum drive size was 137 GB. In earlier drives, the maximum was 2.1 GB.
- **Extended IDE (EIDE) and ATA-2.** Modifications and enhancements of the original *IDE* were marketed as *EIDE* and later standardized as *ATA-2*.
- **ATA Packet Interface (ATAPI).** Originally *IDE* and *ATA* were designed only for hard drives. *ATAPI* provided standards so that *EIDE* and *ATA* versions could be used for other drives, such as CD-ROM and DVD-ROM drives.
- **Renamed to Parallel ATA (PATA).** *ATA* was upgraded regularly to *ATA-7*, which also introduced *Serial ATA (SATA)*. *EIDE* versions were renamed to *PATA* to differentiate it from *SATA*. (*SATA* is described later in this chapter.)

**NOTE SATA HAS REPLACED PATA**

Almost all new systems use SATA drives instead of PATA. However, you're still likely to see some PATA drives in existing systems, and they are listed in the CompTIA objectives.

## PATA Speeds



PATA drives use *direct memory access (DMA)* transfers. DMA allows a device to directly access memory without the central processing unit (CPU), freeing up the CPU for other tasks. *Ultra DMA (UDMA)* appeared in ATA version 4 (ATA-4) and supported data transfers as high as 44 megabytes per second (MBps).

ATA and UDMA were updated several times, and Table 4-1 identifies the speeds and names for the different versions.

**TABLE 4-1** PATA Speeds

Type	Maximum Speed	Comments
ATA-4	33 MBps	Also called UDMA/33 and Ultra ATA/33
ATA-5	66 MBps	Also called UDMA/66 and Ultra ATA/66
ATA-6	100 MBps	Also called UDMA/100 and Ultra ATA/100 Maximum drive size increased to 144 PB
ATA-7	133 MBps	Also called UDMA/133 and Ultra ATA/133

## PATA Connectors and Cables

All PATA connectors are 40-pin rectangular connectors, and they are the same on both the hard drive and the motherboard. Motherboards that support PATA typically have two connectors named IDE 1 and IDE 2 (or sometimes IDE 0 and IDE 1), as shown in Figure 4-2.

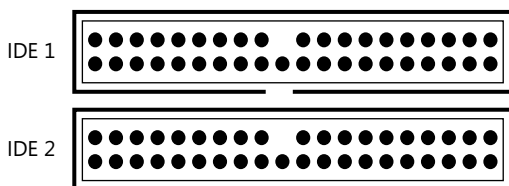
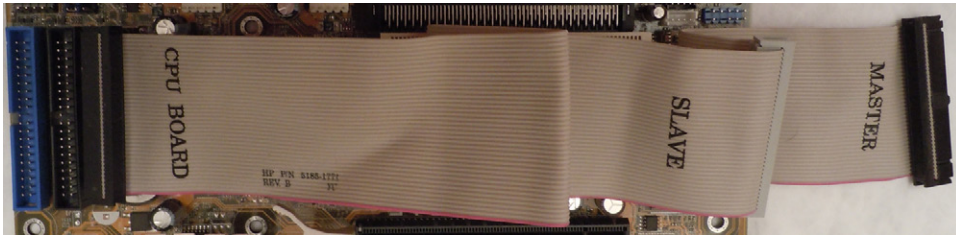

**FIGURE 4-2** IDE connectors on a motherboard.

PATA drives use ribbon cables similar to the one shown in Figure 4-3. Each ribbon cable includes three connectors—one for the motherboard IDE connection and two for the drives. In the figure, the two IDE connectors (IDE 1 and IDE 2) are on the left, and the cable is lying

on top of the motherboard. A typical PATA-based system would have two ribbon cables connecting a maximum of four drives.

Early versions of PATA cables used 40 wires, but this was switched over to 80-wire cables with ATA-4. These extra wires provided signal grounds within the cable and supported the higher UDMA speeds. Even though the number of wires in the cables doubled, the connectors still have 40 pins. The maximum length of an IDE cable is 18 inches.



**FIGURE 4-3** IDE ribbon cable to motherboard.



#### **EXAM TIP**

Most 80-wire UDMA cables are color-coded. The connector on the end (labeled master in the figure) is black, and the middle connector is gray. Also, ribbon cables have a red stripe on one side. The red stripe should match up with pin 1 on the IDE connector.

## Master and Slave Configuration



Each IDE connection supports two drives, and these are commonly identified as *master* and *slave* drives. The system will try to boot to the master drive, but it doesn't automatically know which drive to select. Instead, you have to manipulate jumpers on the drive to let the system know which drive is the master and which is the slave.

#### **NOTE DEVICE 0 AND DEVICE 1**

In later versions of ATA specifications, the master and slave drives were renamed to device 0 (master) and device 1 (slave). However, the master/slave names are commonly used and even mentioned in the CompTIA objectives. You can think of the master drive as simply the first drive for the IDE connector and the slave as the second drive.

Figure 4-4 shows the back of an EIDE drive. You can see that it has a 40-pin connector for the ribbon cable and a Molex connector for power. It also has a set of jumpers used to identify whether the drive is the master or the slave.



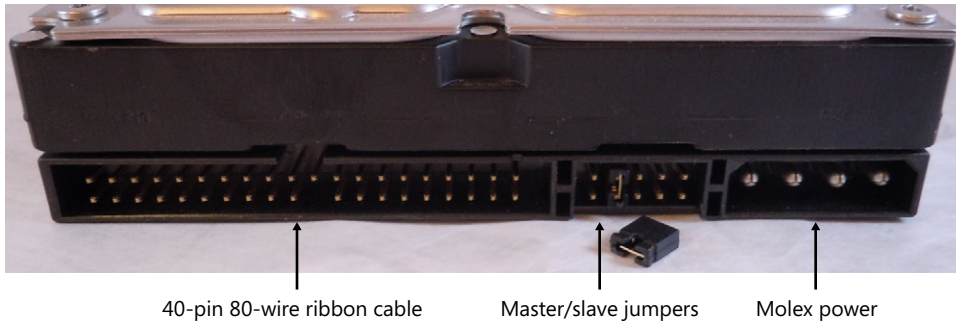

**FIGURE 4-4** Rear of EIDE drive showing jumpers.

If you're replacing or adding a drive, it's important to understand these jumpers. You'll often find a chart on the back of the drive, similar to the chart shown in Figure 4-5, that identifies exactly how the jumper should be configured for each drive.

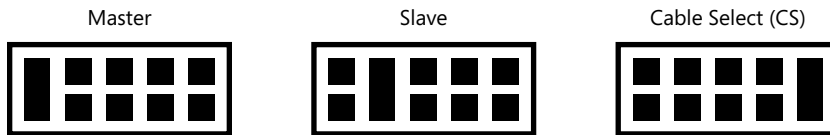

**FIGURE 4-5** Example chart for jumpers on an EIDE drive.



**EXAM TIP**

The most common reason why drives aren't recognized after an installation is that the jumpers are not configured correctly. If you've replaced a drive but find it isn't recognized, double-check the jumpers.

## Cable Select



*Cable select* allows the system to identify the drive based on which connector is used. In Figure 4-3, you can see that the end connector of the ribbon cable is labeled Master and the middle connector is labeled Slave. If you configure the jumpers for both drives to use cable select, they are identified based on which connector is used. If the drives are jumpered for master and slave, the connector does not identify the drive.

## PATA Power

PATA hard drives use a standard four-pin Molex connector, as shown in Figure 4-4 earlier. A four-wire cable from the power supply uses the following colors:

- Yellow 12 V
- Black ground (two middle wires)
- Red 5 V

Chapter 1, "Introduction to Computers," included a picture of the power supply with a Molex connector coming from the power supply.

### Quick Check

1. What type of cable is used with PATA drives?
2. Which connector identifies the master PATA drive?

### Quick Check Answers

1. 40-pin ribbon cable.
2. The end connector when both drives are configured to use CS.

## SATA

---

*Serial ATA (SATA)* drives have replaced PATA drives in almost all new systems. The newest version, SATA 6G, can transfer as much as 600 MBps. In contrast, PATA ATA-7 tops out at 133 MBps.



### EXAM TIP

SATA drives are much faster and much more prevalent than PATA drives. You should know the speeds of each generation, in addition to details about the cables and connectors. Each new version is backward-compatible with earlier versions.

---

## Serial to Parallel to Serial

Early data transmissions sent data between components one bit at a time, or serially. Engineers later improved this by sending multiple bits at a time to improve the speed. Therefore, data could be sent using multiple wires so that bits were next to each other or in parallel. The tradeoff was that the cable needed more wires to send all the data at the same time.

For example, a 40-pin EIDE ribbon cable includes 16 bits for data. If you send 16 bits at a time, you can send as much as 16 times more data than if you send just one bit at time at the same speed. The idea that parallel is faster than serial held for many years, until a breakthrough with *low voltage differential (LVD)* signaling occurred.

LVD signaling is a standard that transmits data as the difference in voltages between two wires in a pair. These differences can be rather small, and engineers discovered they could send data serially along an LVD cable quicker than they could with parallel. Many technologies use LVD signaling, including SATA drives, HyperTransport used by AMD processors, and FireWire.

# SATA Generations

Three generations of SATA are currently in use. It's important to know the capabilities of each and also to recognize the different names that have been used. Table 4-2 outlines the different versions and their speeds.

**TABLE 4-2** SATA Versions

Generation	Bit speed	Byte speed	Names
SATA 1	1.5 Gbits/s	150 MBps	SATA 1.5G, SATA 1.5Gb/s, SATA 1.5Gbit/s, SATA 150
SATA 2	3.0 Gbits/s	300 MBps	SATA 3G, SATA 3Gb/s, SATA 3Gbit/s, SATA 300
SATA 3	6.0 Gbits/s	600 MBps	SATA 6G, SATA 6Gb/s, SATA 6Gbit/s, SATA 600

PATA versions are commonly described using speeds rated in bytes per second (Bps), and SATA versions often use bits per second (bps or bits/s). For example, SATA 1.0 can transfer data at 150 MBps, but it is commonly listed as 1.5 Gbit/s.

### **NOTE BITS TO BYTES AND 8B/10B ENCODING**

If you multiply 150 MB by 8 to convert bytes to bits, you get 1.2 gigabits, not 1.5 gigabits, yet 150 MBps and 1.5 Gbits/s are both valid figures for SATA 1.5G. SATA uses 8b/10b encoding, which transmits each group of 8 bits (each byte) as a 10-bit symbol or code. If you divide 1.5 Gbits (1,500 Mbits) by 10, you get 150 MB.

One of the things that has confused people about SATA is the similarity of the names SATA 3.x and SATA 3G. Some products are marketed as SATA 3G, and customers think they are getting a third-generation SATA product. However, as you can see from Table 4-2, SATA 3G refers to a transfer rate of 3 Gbits/s provided by the second generation of SATA.

## SATA and SSD

Before SATA, hard drives were typically capable of sending data faster than the motherboard could accept it. The interface was the bottleneck. Even though each newer ATA version allowed faster data transfers, the drives were still faster than the interface.

It's different with SATA 6G. You won't be able to find a mechanical hard drive that can transfer as much as 6 Gbits/second (or 600 MBps). Some extremely fast (and extremely expensive) hard drives can transfer data as quickly as 157 MBps. That is, these drives benefit from using SATA 3G but they never exceed 300 MBps, so they don't benefit from SATA 6G. You just won't see any performance difference in these hard drives if you plug them into a SATA 3G or SATA 6G port.

With this in mind, you might be wondering why you'd want SATA 6G. It's a great question. The answer is for solid state drives (SSDs). SSDs are discussed later in this chapter, but in short,

they don't have any moving parts and are much faster. SSDs are available that can read and transfer data as fast as 500 MB/s.

## SATA Data Connectors and Cables

SATA cables are much smaller than the 80-wire ribbon cables used with PATA. They include only seven wires, and cables can be as long as 1 meter (about 3.3 feet). A distinctive characteristic of SATA cables is that they have an L-shaped connector, which works as a key. Each drive is connected to a single SATA connector on the motherboard, so you don't have to worry about master/slave jumpers on SATA drives.

Figure 4-6 shows part of a motherboard with five SATA ports. SATA 5 is on the left as a single unoccupied port. Ports 1 and 2 are stacked and ports 3 and 4 are stacked, allowing more ports in the same amount of space.

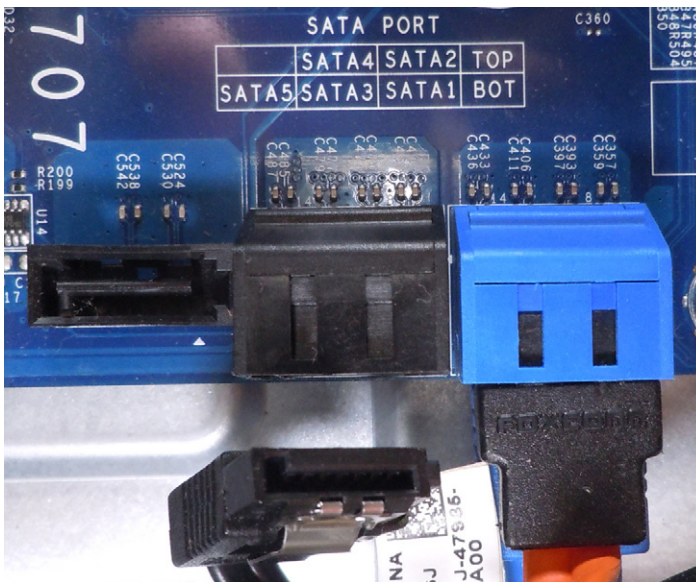

**FIGURE 4-6** SATA connectors on a motherboard.

I removed the connector from the SATA 3 port so that you can see it, and I left SATA ports 1 and 2 connected. The other ends of these cables connect to similar L-shaped ports on the SATA drive.

The SATA ports on a motherboard are commonly color-coded, but there isn't a standard. For example, on this motherboard, SATA 1 and SATA 2 are both blue, and the other three connectors are black. The documentation for the motherboard states that the blue ports are 6 Gbit/s SATA 6G ports and that the black ports are 3 Gbit/s SATA 3G ports.

Also, you'll run across different-colored SATA cables, but the colors don't indicate a specific version. They do help you trace the cables. If you have five black SATA cables going to five

different drives, it's difficult to tell which drive is connected to which port. However, when the cables are different colors, it's easier to trace them from the port to the drive.

## SATA Power Connectors and Cables

SATA power connectors have 15 pins, but the cables have only five wires. The color coding for the wires is as follows:

- **Orange**—3.3 V to pins 1, 2, and 3.
- **Black**—Ground to pins 4, 5, and 6.
- **Red**—5 V to pins 7, 8, and 9.
- **Black**—Ground for pins 10, 11, and 12. Pin 11 can be used to delay the startup of the drive or to indicate drive activity.
- **Yellow**—12 V to pins 13, 14, and 15.

Figure 4-7 shows the back of a SATA drive, along with the power cable from the power supply. The SATA data connection is on the right, and you can see that both have the distinctive L-shaped key, although the power connector is larger. Also, the power connector has a square tip on one side.

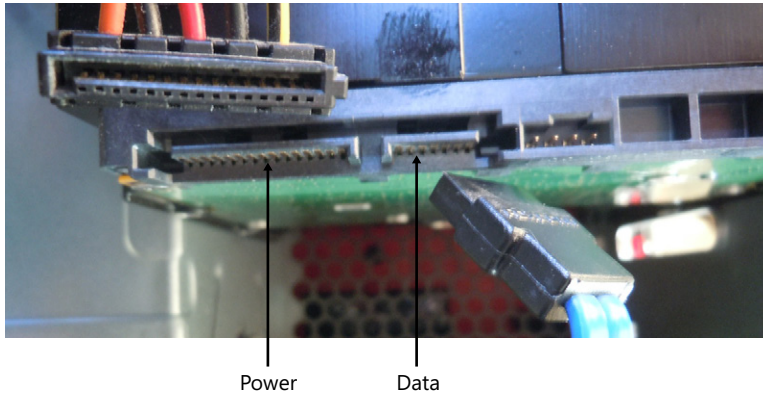

**FIGURE 4-7** SATA power and data connectors.



### **EXAM TIP**

In some cases, you can use an adapter to connect a 4-pin Molex power cable from the power supply to a SATA drive. The Molex cable does not provide 3.3 V, so the adapter includes electronics to convert power to 3.3 V for pins 1, 2, and 3.

## Hot-Swappable



All versions of SATA drives are *hot-swappable*, which means that you can plug in or remove the drive while the system is powered on. Several ground pins on the power cable are longer than the pins carrying voltage so that the ground pins connect first. This prevents any damage when they are plugged in. In contrast, you must power down a system before replacing a PATA drive.

You're not likely to replace an internal SATA drive while the system is powered on. However, some systems have drive bays that allow you to plug in or remove a drive from the front panel or that are in an external enclosure. If a drive fails, you can swap it out without powering down the system.

### **NOTE HOT-SWAPPABLE**

Hot-swappable refers only to the hardware ability. If you remove a device while a program is writing data to it, it can corrupt data. Ensure that the device is not being used before removing it.

### **Quick Check**

1. What are the speeds of SATA 2 and SATA 3?
2. What types of connectors are used with SATA?

### **Quick Check Answers**

1. L-shaped connectors.
2. SATA 2 is 3 Gbps, and SATA 3 is 6 Gbps.

## SCSI



*Small Computer System Interface (SCSI, pronounced scuzzy)* is a drive interface standard that has been around as long as the earliest ATA standards. It has traditionally provided higher performance compared to the PATA drives, but it is more expensive and not widely used on desktop computers. With the popularity of SATA drives, SCSI drives are used even less on desktop computers.

The three primary standards used with standard SCSI are as follows:

- **SCSI-1 (also called narrow SCSI).** Uses a 50-pin cable with a maximum transfer rate of 5 MBps. Narrow SCSI uses an 8-bit bus and supports a maximum of 8 devices.
- **SCSI-2.** Uses a 25-pin, 50-pin, or 68-pin cable. This was first called fast SCSI because it could transfer data at 10 MBps, twice as fast as SCSI-1. It originally used an 8-bit bus.

Fast-Wide SCSI is an update that uses a 16-bit bus and supports 16 devices with transfer rates of 20 MBps.

- **SCSI-3.** Uses a 50-pin, 68-pin, or 80-pin cable. The most common cable is an 80-pin Single Connector Attachment (SCA). SCSI-3 is also called Ultra SCSI and includes several different versions.

Table 4-3 lists several recent versions of SCSI-3. Each of these use a 16-bit bus and can support as many as 16 devices.

**TABLE 4-3** Ultra SCSI Types

Type	Speed: bytes per second	Speed: bits per second
Ultra-160	160 MBps	1.28 Gbit/s
Ultra-320	320 MBps	2.56 Gbit/s
Ultra-640	640 MBps	5.12 Gbit/s

## SCSI Interfaces

SCSI cables and connectors come in several different versions. Some are ribbon cables similar to the cables used with PATA drives, and other cables are round. Some examples of SCSI connectors include:

- **25-pin.** This is a very old SCSI connector, also known as a DB25. It has one row of 13 pins and a second row of 12 pins.
- **50-pin.** Several types of 50-pin SCSI connectors have been used. Some have two rows, and some have three rows. A Centronics 50-pin connector has connectors lined up in slots.
- **68-pin.** This includes two rows of pins close together and is referred to as high-density. It is sometimes used for external SCSI connections.
- **80-pin.** This is known as a Single Connector Attachment (SCA) connection, and it is used as an alternative to 68-pin connections. It includes pins for both data and power and supports hot-swapping.

## SCSI IDs



SCSI devices are controlled by a SCSI controller. Each device, including the controller, is assigned a *SCSI identifier (SCSI ID)* using numbers from 0 to 15. The controller is normally assigned the highest priority SCSI ID of 7. The priorities don't make sense unless you know a little SCSI history.



### EXAM TIP

You should know the priority order of SCSI IDs and that the controller is assigned the highest priority SCSI ID of 7.

Early SCSI implementations supported eight devices and used SCSI IDs numbered 0 to 7, with SCSI ID 7 being the highest priority and SCSI ID 0 being the lowest. When SCSI began supporting 16 devices, they added 8 SCSI IDs (8 to 15). However, they did not modify the original priorities. Instead, the additional 8 device IDs (8 to 15) were given lower priorities than the first 8 IDs. In the second set of 8 IDs, 15 is the highest and 8 is the lowest. Therefore, the priority order from highest to lowest is as follows:

- 7, 6, 5, 4, 3, 2, 1, 0, 15, 14, 13, 12, 11, 10, 9, and 8.

When you need to assign an ID to a device with a jumper, you'll often see four jumpers, listed as 3, 2, 1, 0. These refer to four binary bits that can be used to count from 0 to 15. These bits have the values 8, 4, 2, and 1.

### MORE INFO CHAPTER 1

Chapter 1 covered binary numbering systems. As a reminder,  $2^3$  is 8,  $2^2$  is 4,  $2^1$  is 2, and  $2^0$  is 1. Jumper 3 is used for  $2^3$ , jumper 2 is for  $2^2$ , jumper 1 is for  $2^1$ , and jumper 0 is for  $2^0$ .

For example, if you wanted to assign the number 7 to a controller, you would use the binary number 0111. The jumper for 3 would be removed to indicate a 0, and the jumpers for 2, 1, and 0 would be installed to indicate 1s. Table 4-4 shows the binary values for IDs 0 to 15.

TABLE 4-4 SCSI IDs Binary Values

ID	Binary	ID	Binary	ID	Binary	ID	Binary
0	0000	4	0100	8	1000	12	1100
1	0001	5	0101	9	1001	13	1101
2	0010	6	0110	10	1010	14	1110
3	0011	7	0111	11	1011	15	1111

In some cases, the SCSI ID can be assigned through the SCA adapter or with software. You might not need to assign it with jumpers.

## Daisy-Chaining and Termination



SCSI devices are connected together in a *daisy chain* fashion, which indicates that devices are connected to each other like links in a chain rather than each device being connected directly to a central device.



Figure 4-8 shows how internal and external devices can connect to a SCSI controller. The SCSI controller is an expansion card plugged into the motherboard, and it has an internal connection for internal devices and an external connection for external devices.

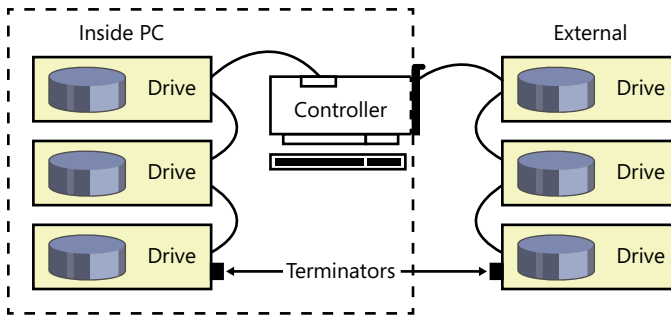

**FIGURE 4-8** Daisy-chaining SCSI devices.

Each device has two connectors to support the daisy chain connection. Additionally, the last device in the chain must be terminated to let the controller know that there aren't any additional devices in the chain. The figure shows both an internal chain with three drives and an external chain with three drives. Each chain must be terminated.

The terminator can be a plug that plugs into the connector or a switch that indicates which is the last device. In most new systems, the terminator is automatically configured. The last device recognizes that there is nothing plugged into the second connector, so it automatically terminates the connection.

## Serial Attached SCSI



*Serial Attached SCSI (SAS)* is a newer form of SCSI that uses a serial interface. It uses data and power cables similar to the SATA connections and supports transfer speeds of up to 6 Gbit/s. SAS is used in some high-end servers but is more expensive than SATA, so it is rarely used in desktop computers.

## External Connections Types

If you don't have room inside your computer or you just want to have something portable, you can add an external drive. This includes adding an external hard disk, optical drive, tape drive, or a floppy drive. The following sections describe common ways you can add an external drive.

## USB

Almost every computer has Universal Serial Bus (USB) ports, and many external devices use them. USB 2.0 supports speeds of up to 480 Mbits/s, and USB 3.0 supports speeds of up to 5 Gbits/s. USB cables can be as long as 5 meters (over 16 feet), and you can attach as many as 127 devices to any single USB hub.

### **MORE INFO** CHAPTER 5, “EXPLORING PERIPHERALS AND EXPANSION CARDS”

Both USB and FireWire are covered in more depth in Chapter 5.

Figure 4-9 shows several ports accessible on the back of a computer, and the four ports on the top left are USB ports. Computers will often have additional USB ports available on the front panel.

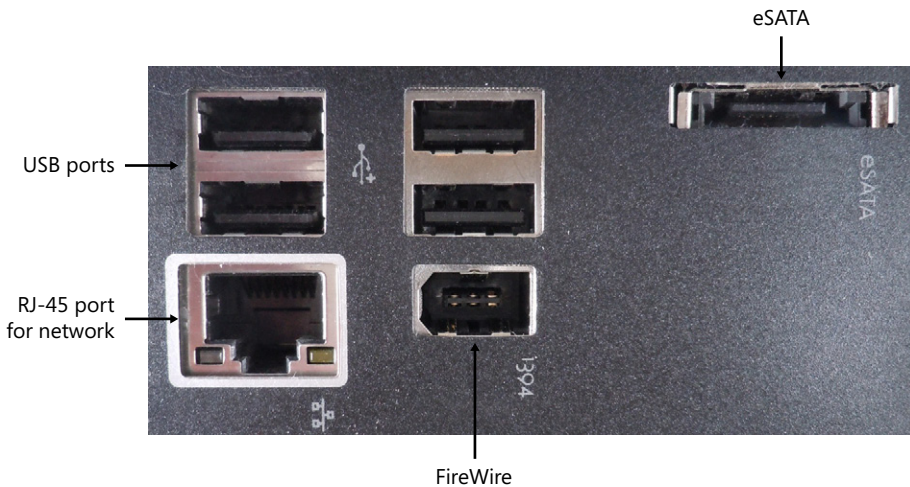

**FIGURE 4-9** Ports on back of computer.

### **NOTE** USB LOGO WITH PLUS SIGN

The USB logo starts with a circle on one end, then has a trident of a circle, an arrow, and a square on the other end. Some USB 2.0 ports are also labeled with a plus sign (as shown in Figure 4-9) to indicate that it is USB 2.0.

## FireWire

Many computers also have a FireWire port. FireWire was created by Apple and then formalized as IEEE 1394, so you'll see it with both names. Figure 4-9 shows a single FireWire port labeled 1394. FireWire 400 (or 1394a) supports speeds of up to 400 Mbps, and FireWire 800

(or 1394b) supports speeds of up to 800 Mbps. FireWire cables can be as long as 4.5 meters (almost 15 feet), and you can daisy-chain as many as 63 devices to a single FireWire port.

FireWire ports can have 4, 6, or 9 pins. The port shown in Figure 4-9 is a 6-pin port, and it provides power to the device (as does a 9-pin FireWire port); 4-pin connectors do not provide power.

## eSATA

SATA was originally designed for internal use only but is emerging as another alternative for external drives. There is no performance difference between SATA and eSATA, and most eSATA ports are based on SATA 3G providing transfer speeds of up to 3 Gbit/s.

Figure 4-9 includes an eSATA port, and you can see that it lacks the distinctive *L* shape of internal SATA connections. The eSATA cables have seven wires, just like internal SATA cables, but eSATA cables require shielding that isn't needed with internal SATA cables. The different connector ensures that an internal cable isn't used for an external connection.

The eSATA cable can be as long as 2 meters (about 6.6 feet), but unlike with USB and FireWire, you can connect only one device to the port.



### **EXAM TIP**

If the eSATA drive is not recognized when you plug it in, there are two primary things to check. First, check the BIOS to ensure that the eSATA port is enabled. Second, ensure that you have drivers for the device. These will normally be available from the manufacturer.

## eSATAp

Many laptop computers include a powered eSATA (*eSATAp*) port. It's also called an eSATA/USB combo or eSATA USB Hybrid Port. It can be used for either an eSATA device or a USB 2.0 (or earlier) device. You simply plug in the device, and the system automatically recognizes whether it is eSATA or USB and uses the correct interface.

### **NOTE SATA VS. USB**

SATA and USB are competing standards, and the eSATAp port that supports both USB and eSATA devices is not a formal standard. However, it is very common on laptop computers.

Figure 4-10 shows the side view of a laptop computer. It includes an eSATAp port, a standard USB port, and a 4-pin FireWire port.

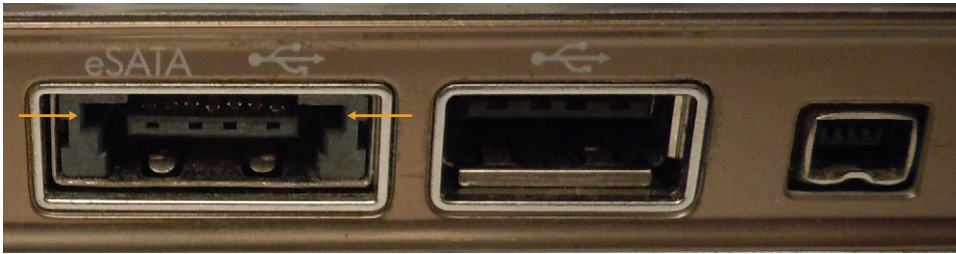

**FIGURE 4-10** Connectors on side of laptop.

The eSATAp port includes the 7 pins used by eSATA and 4 pins used by USB. If you plug in a USB device, it uses the 4 USB pins. If you plug in an externally-powered eSATA device with a standard eSATA cable, it uses the 7 pins for data, just like the eSATA port described previously.

Some smaller devices, such as solid state drives or 2.5 inch drives, can be powered by the 5 V available on the USB pins. A special eSATAp cable carries both the data and 5 V to the device.

Larger devices, such as 3.5-inch drives and optical drives, require 12 V power. Some eSATAp ports on desktop computers include two optional pins (located at the white arrows in Figure 4-10) that provide 12 V. If 12 V is provided via the eSATAp port, you can use a 12-V eSATAp cable that will deliver data, 5 V, and 12 V to the device.

**IMPORTANT ALL ESATAP CABLES AREN'T THE SAME**

Some eSATAp cables carry both 5 V and 12 V, but most carry only 5 V. If an eSATAp device isn't working, check to see whether 12 V is required. If it is, verify that the eSATAp port has the additional pins for 12 V and that the eSATAp cable includes 12-V support. You can always use a standard eSATA data cable and provide external power to the device.

## Ethernet

Another way you can add external data storage is with a network drive. You don't connect the network drive directly to the computer. Instead, you connect the network drive to a device such as a router or a switch. This is commonly called network attached storage (NAS).

For example, many people have home networks using wireless routers. It's relatively easy and inexpensive to add a NAS device to the network. Users with network access can then share the drive.

Figure 4-9 includes an RJ-45 port used to connect a computer to a network. You would typically connect this to a switch with a twisted-pair cable. Similarly, network drives commonly have an RJ-45 port used to connect them to a network. However, you would not connect the NAS device directly to a computer by using this RJ-45 port.

## **MORE INFO NETWORKING**

Networking topics are covered in Chapters 18 through 24, and NAS is covered in Chapter 18, “Introducing Networking Components.”

## **External Enclosures**

As a technician, you’ll find that an external hard drive enclosure is a handy tool. Instead of installing a drive inside a computer, you can install it in the enclosure and use it as an external drive.

You can find enclosures that will accept IDE/PATA drives and others that accept SATA drives. Also, some are designed to accept the 2.5-inch drives from laptop computers and others will work with 3.5-inch drives common in desktop computers. After installing the drive, you connect the enclosure to a computer with a USB connection.

For example, if a laptop fails, you might want to access the data on the hard drive. You can remove the hard drive from the laptop, install it in the enclosure, and plug the enclosure into a working computer. It will now work just like any other external drive.



### **Quick Check**

1. What is the most common connector used for peripherals?
2. What can you plug into an eSATAp port?

### **Quick Check Answers**

1. USB.
2. USB or eSATA devices.

## **Solid State Drives**



*Solid state drives (SSDs)* don’t have any moving components but instead use only electronics to store and retrieve data. You can think of an SSD as a huge bank of random access memory (RAM). Most SSDs are nonvolatile, meaning that they won’t lose data when power is removed. The most common type of memory used with SSDs is flash-based RAM, the same type of nonvolatile RAM used in USB flash drives.

SSD drives are lightning-fast when compared with mechanical hard drives. Additionally, they don’t require motors to spin the platters and move the actuator, so they are lighter and draw less power. Mobile devices such as tablets commonly use SSDs, and many hobbyists replace laptop hard drives with SSDs.

With the price of memory continuing to fall, SSD drives have become very affordable. For example, you can purchase a 128-GB SSD drive for about the same price as a 2-TB mechanical drive. Some people use an SSD drive for the operating system and applications and use a mechanical drive for data. Most SSD drives use SATA and will install just like any other SATA drive.

In addition to SSD drives and USB flash drives, several types of flash memory are used in digital cameras and recorders, including the following:



- **CompactFlash (CF).** *CompactFlash* devices are manufactured by SanDisk and are very popular. The outer dimensions are 43 × 36 mm. Type 1 CF devices are 3.3 mm thick, and Type II devices (known as CF2) are 5 mm thick. They can hold up to 128 GB of data.
- **SD (Secure Digital).** *SD* is developed by the SD Card Association and used with many types of portable devices. It supersedes MultiMediaCard (MMC), which is the same size. Figure 4-11 shows a Compact Flash stick next to a standard SD stick. The dimensions of SD are 24 × 32 mm. They can hold up to 2 GB of data. Newer versions include SD High Capacity (SDHC) and extended Capacity (SDXC). SDHC can hold up to 32 GB, and SDXC can hold up to 2 TB of data.



**FIGURE 4-11** CompactFlash and SD memory sticks.



- **Mini-SD.** This is a smaller version of the SD card. The dimensions of *mini-SD* devices are 21.5 × 20 mm.
- **Micro-SD.** This is the smallest of the three SD sizes. The dimensions of *micro-SD* devices are 15 × 11 mm.
- **xD.** The *xD* Picture card is an older flash memory card used in some digital cameras. It was developed by Olympus and Fujifilm, but Olympus cameras are now using SD cards.

Many computers have connectors on the front panel that will accept these memory sticks. This enables you to remove the memory from your camera and plug it directly into the computer to access the pictures.

# Optical Discs and Drives



If you've used a computer or watched a movie at home, you've probably seen and handled an optical disc. However, you might not be aware of the different types of *compact discs (CDs)*, *digital versatile discs (DVDs)*, and *Blu-Ray discs (BDs)* currently available.

## NOTE DISK VS. DISC

When referring to hard disk drives, the correct spelling is *disk*, with a *k*. When referring to optical disc drives and optical discs, the correct spelling is *disc*, with a *c*.

Table 4-5 lists the different types of optical discs and their capacities. In this context, ROM indicates that it is read-only media (ROM), but it is possible to write to discs.

TABLE 4-5 Media Capacity

Type	Capacity	Comments
CD-ROM	700 MB (80 minutes of audio)	The standard size is 12 cm (4.7 inches).
Mini CD-ROM	194 MB (24 minutes of audio)	These are 6 to 8 cm. Vendors sometimes release software or audio using this size.
DVD-ROM	4.7 GB	Dual-sided DVD-ROMS hold 4.7 GB on each side.
Dual-Layer DVD-ROM	8.5 GB	Dual-sided dual-layer DVD-ROMS hold 8.5 GB on each side.
Blu-Ray Single-layer	25 GB	Blu-Ray discs use a blue laser, and CD and DVDs use a red laser.
Blu-Ray Dual-layer	50 GB	This is the common size used for movies. Triple-layer holds 100 GB, and quad-layer holds 128 GB.



## EXAM TIP

Know the capacity of the different discs as shown in the table.

## Combo Drives and Burners

Most optical drives support multiple types of optical discs. It's common to have a single optical disc drive that can read and write CDs and DVDs. For just a little more money, you can get a combo drive that can also read and write Blu-Ray discs.

Optical discs use lasers to read and write data. The process of writing data to a disc is commonly called *burning a disc*. However, you can't burn just any disc. For example, CD-ROMs and DVD-ROMs are read-only media. You can't overwrite the data on these discs. However, you can burn data to R, RW, and RE discs.



- **R (Recordable).** A recordable disc can have data written to it once. It is sometimes referred to as *write once read many (WORM)* and is used for backups and archives. It is possible to write the data in multiple sessions, but after an area is written on the disc, it cannot be rewritten. The R applies to CDs (as in *CD-R*), DVDs (as in *DVD-R*), and Blu-Ray discs (as in *BD-R*).
- **RW (Rewritable).** A rewritable disc can be rewritten many times. The RW applies to CDs (as in *CD-RW*) and DVDs (as in *DVD-RW*).
- **RE (Recordable Erasable).** Blu-Ray discs use RE (as in *BD-RE*) to indicate that the disc is rewritable.

**NOTE +R, +RW, -R, AND -RW**

CDs and DVDs come in + and – versions, such as DVD-R and DVD+R. These are competing versions of discs, but most combo drives and burners will be able to read and write data using both types of discs. However, if you plan on making a DVD that you want to play on a DVD player, you might have problems—many players support only one disc type or the other.

If you insert an optical disc that is not recognized by the drive, applications will often just ignore it. For example, you might decide to copy a DVD disc from DVD drive 1 in your system to DVD drive 2. If you put a CD disc instead of a DVD in drive 2, you won't receive an error saying that you've installed a CD. Instead, you'll be prompted to insert a DVD.

## Speeds

The speeds of optical disc drives are stated as multipliers using a base speed. The base speeds are as follows:

- **CD:** 150 KBps
- **DVD:** 1.39 MBps
- **Blu-Ray:** 4.5 MBps

For example, you might see a DVD drive listed as 24x for R and 8x for RW. This indicates that it can write to a recordable disc at a speed of  $24 \times 1.39$  MBps and that it can write to a rewritable disc at a speed of  $8 \times 1.39$  MBps.

## Installing Optical Drives

Here's some good news: if you understand how to install PATA and SATA drives, you know how to install an optical drive. Optical drives come in both PATA and SATA versions, and you install them the same way you install those drives.

If it's a PATA optical drive, you need to ensure that the master/slave jumpers are configured correctly to recognize the drive. If it's a SATA drive, just plug the cables in and ensure that the SATA port is enabled in BIOS. If it's a SATA optical drive, it uses a SATA power connector. Older PATA drives use the standard PATA Molex power connector.



The only other consideration is that older CD-ROM drives need an audio cable connected from the drive to either the motherboard or the sound card. Figure 4-12 shows the back of an IDE-based drive that includes audio connections. Newer drives can send the audio through the IDE or SATA cable, so this extra cable is not needed.

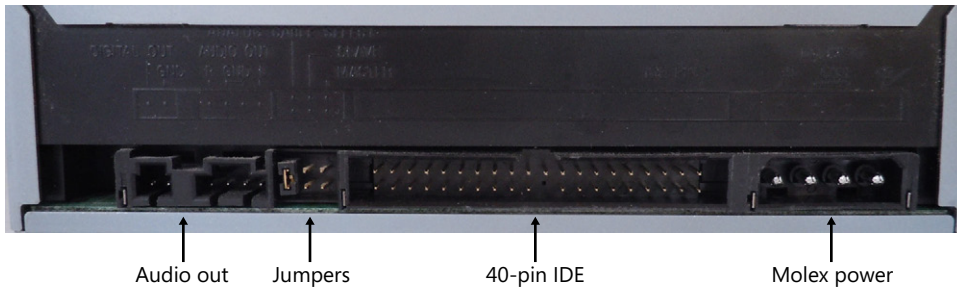

**FIGURE 4-12** Connectors on back of optical drive.

## Removing Discs Without Power

There might be a time when you need to remove a disc from a drive but don't have any power. It could be that the drive has failed and won't power up, or it could be you are disposing of an old computer and want to ensure that there isn't a disc left in the system. You can open the drive with a paperclip.

All disc drives have a small pinhole in the front. Unbend a paperclip and poke it into the hole to manually open the drive.



### Quick Check

1. How much data can you store on a single-layer Blu-Ray disc?
2. What does RE indicate with an optical disc?

### Quick Check Answers

1. 25 GB.
2. Recordable Erasable.

## Tape Drives

Tape drives are often used to back up large amounts of data. A tape drive can read and write data by using reusable magnetic tapes, and the tapes are contained within tape cartridges. Tape cartridges that hold 320 GB of data are widely available.

In many organizations, backups are scheduled to occur in the middle of the night. A technician ensures that a tape is in the drive before leaving. The next day, the technician checks

the backup for errors, stores the backup tape, and inserts another tape. If data is ever lost or corrupted, it can be retrieved from these tapes. In larger organizations, tape libraries house multiple tapes in holding slots, which are automatically inserted into drives as needed.

Two common tape cartridge types are as follows:



- **Digital Linear Tape (DLT).** These are self-contained tape cartridges that come in different capacities and qualities. *DLT* can transfer data as fast as 60 MB/s, and cartridges as large as 800 GB are available.
- **Linear Tape-Open (LTO).** *LTO* is a newer, faster standard. The cartridges are about the same size but can hold more data and transfer it faster. *LTO-5*, released in 2010, can transfer data at 140 MB/s and can hold as much as 1.5 TB.

When using tapes, there is an initial cost and a recurring cost for new tapes as tapes wear out. For example, imagine that an organization has a large database and wants to back it up daily and retain backups for a year. A common backup strategy requires about 20 tapes to hold different backups—daily, weekly, monthly, quarterly, annually, and for off-site storage.

Backup tape drives commonly use SCSI interfaces. Internal drives will use one of the Ultra SCSI versions, and external SCSI drives often use SAS.

It's very rare for a regular user to use a tape drive for backups. It's often cheaper and easier to back up data to an external hard drive or even to an optical disc.

## Floppy Drives

---



For many years, floppy disks were the primary way many people copied files from one system to another. USB flash drives have replaced them and made them all but obsolete. You might not even see a system with a *floppy disk drive (FDD)* today, but they are specifically mentioned in the objectives.

Older disks were 5.25 inches and were bendable, giving them their “floppy” name, but the most recent version is 3.5 inches and not very floppy or bendable. In the original IBM PC computers, users booted their system up with this disk. It was identified as the A drive. Dual floppy disk systems had a second one, identified as the B drive.

### **NOTE A AND B DRIVE NAMES**

Even though you might never see or use a floppy, the letter names A and B are still reserved for floppies. The first hard drive starts with the letter C.

Floppy drives can hold 1.44 MB of data. It's relatively easy to create a bootable floppy disk, and for years, technicians kept bootable floppies that included software troubleshooting tools. When a system failed, they booted the system to the floppy and ran tests from there. Today it's more common to use a bootable CD or DVD or a bootable USB flash drive for this purpose.

## Recovering Data

There was a time when 1.44 MB of data was considered a lot, and many users copied data onto a floppy for long-term storage. The primary reason why a system might have a floppy drive today is to recover this archived data.

## Floppy Connections

Floppy disk drives are usually mounted inside the computer, with the slot for the floppy disk accessible from the front panel. They have two primary connectors:

- **Power.** A 4-pin mini-Molex connector provides power. Chapter 1 shows a picture of a common power supply including this connector.
- **Data.** The data cable is a 34-pin ribbon cable similar to the 40-pin ribbon cable used with PATA drives. Connectors aren't always keyed, but the red stripe on the ribbon cable should go to pin 1 on the motherboard and pin 1 on the floppy drive.



---

### EXAM TIP

A common problem with floppy disk installations was connecting the ribbon cable backwards on one of the connectors. Typically, the floppy LED stays lit and drives aren't recognized. In some cases, data on the floppy is corrupted.

---

Many floppy drives have a jumper to identify the first and second drive (drive A and drive B). It was common to leave them both set to drive A and use a ribbon cable with three connectors and a twist before the last connector. You'd connect the last connector to drive A and the middle connector to drive B. It's also possible to manipulate the BIOS to designate which drive is which.

If you come across a floppy drive that isn't working, check the BIOS to see whether it's disabled. They are rarely used in day-to-day work, so it could be disabled without anyone noticing.

## RAID



---

A *redundant array of independent (or inexpensive) disks (RAID)* uses multiple disks to provide increased performance and fault tolerance. In general, fault tolerance refers to any system that can suffer a fault but can still tolerate the error and continue to operate. With RAID, a disk can fail but the system will continue to operate.

Fault tolerance is achieved by using extra disks in specific configurations. When extra components are added for fault tolerance, they are commonly referred to as *redundant components*.

Both software-based RAID and hardware-based RAID are available. In software-based RAID, the operating system manages the RAID configuration. For example, in Windows-based

systems, you can use dynamic disks and create software-based RAID arrays. One big benefit is that it doesn't cost anything.

### **MORE INFO CHAPTER 16**

Chapter 16 covers RAID configurations supported within Windows. Windows 7 uses dynamic disks, which can be used to create RAID-0 and RAID-1 disk arrays.

Hardware-based RAID is supported on some motherboards, and you can also purchase external hardware-based arrays. Hardware-based RAID arrays outperform software-based arrays, so if you can afford it, it's a better option. The operating system views a hardware-based array simply as another disk.

There are multiple types of RAID, but the exam focuses on only four: RAID-0, RAID-1, RAID-5, and RAID-10.

## **RAID-0**



RAID-0 uses two or more disks and is commonly called *striping* or a *striped volume*. It does not provide fault tolerance. However, because the data is spread across multiple disks, the system can read and write to the array more quickly than it can read or write to a single disk.

Imagine that you had a file named Study Notes and that it took exactly 100 milliseconds (ms) to save it to a single disk. The majority of this time is taken by physical components in the hard disk, so if you could save parts of the file to two disks at the same time, you could cut the time almost in half, as shown in Figure 4-13. There is some overhead from other components, such as the disk controller, so it's not exactly half. When it needs to read the file, the array reads it from each disk at the same time, so reads are quicker, too.

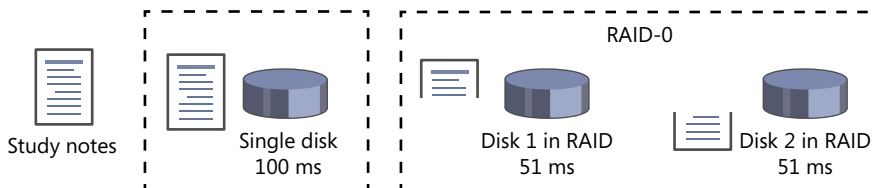

**FIGURE 4-13** Comparing a single disk with RAID-0.

What if one of the disks fails? The system can't interpret half-files, so all the data is lost. At this point, you'd better hope you have a backup.

You can use more disks in a RAID-0 configuration for better read and write performance. For example, if you have four drives, it takes about 25 percent of the time for a read or write compared to a single disk. However, each additional disk adds risk. For example, if you have four disks in a RAID-0, you're four times more likely to experience a failure, and if one drive fails, all the data is lost.

## RAID-1



*RAID-1* uses two disks only and is commonly called *mirroring* or a *mirrored volume*. Everything that is written to one physical disk in the RAID-1 is also written to the second disk. The biggest benefit is fault tolerance. If one drive fails, you still have a copy of the data on the second drive.

Figure 4-14 compares this to a single disk. Because you're writing the entire file to a single disk, you don't get any write performance gains. However, many RAID-1 controllers recognize that the other disk has the same file and can read from both disks simultaneously. Therefore, RAID-1 often provides increased read performance.

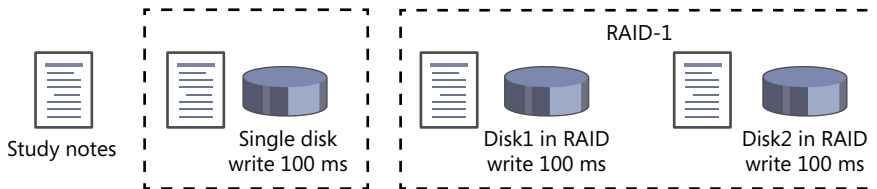

**FIGURE 4-14** Comparing a single disk with RAID-1.

The primary drawback of a RAID-1 is that you have less usable disk space. If you create it with two 500 GB disks, you have only 500 GB of usable disk space.

Some RAID-1 configurations can automatically switch over to the other disk if one disk fails. You'll see some type of error or notification, but the system will continue to run.

In other RAID-1 configurations, you might have to manually intervene. For example, if Disk 1 from Figure 4-14 failed, you might have to reconfigure the system to use Disk 2 in place of Disk 1. If the RAID-1 is being used as the boot disk, you might have to reconfigure a system file to boot from Disk 2. Or, you might need to reconfigure the drives so that Disk 2 is recognized as Disk 1.

### **NOTE** DUPLEXING

As an additional measure, some RAID-1 configurations include an additional disk controller. Each drive uses a dedicated controller. This is called *duplexing*, or *RAID-1 duplexing*, and ensures that the system continues to operate even if one controller fails.

## RAID-5



*RAID-5* uses at least three disks and is commonly called *striping with parity*. It uses the equivalent of one drive as parity to provide fault tolerance. Chapter 3, "Understanding RAM and CPUs," describes parity as a method of error detection used with memory. RAID-5 uses it as a method of fault tolerance.

As an example of how parity works with RAID-5, consider Table 46. It includes the decimal numbers 0 through 3. Each of these numbers can be represented with two binary bits. For example, the decimal number 1 is represented as 01 and the decimal number 2 is 10.

**TABLE 4-6** Calculating Odd Parity with RAID-5

Decimal Number	Data Bit 1 21 (2)	Data Bit 0 20 (1)	Number of 1's in Bits	Odd Parity
Zero (0)	0	0	Zero	1
One (1)	0	1	One	0
Two (2)	1	0	One	0
Three (3)	1	1	Two	1

On a RAID-5, a group of data bits are combined with parity in a stripe. For example the row for three includes three bits in the stripe: 1 and 1 for the data and 1 for parity.

The parity bit is set to a 0 or a 1 to ensure that the stripe has an odd number of 1 bits. For example, three is represented as 11. The system calculates the number of 1 bits in 11 as two. The number two is even, so the parity bit is set to 1 so that the total number of 1 bits in the stripe is three (an odd number). Similarly, two is represented as 10, which is one 1 bit. One is odd, so the parity bit for the stripe is set to 0.

In a RAID-5, you will always have at least three drives, and the equivalent of one drive is used for parity. When a RAID-5 array writes data to a drive, it calculates the parity bit and writes it along with the data.

For example, Table 4-7 shows how you can think of these two data bits and the parity bit as three drives. In the table, Drive 2 has failed and the data isn't available. However, if you can count the number of 1 bits in a stripe and identify even numbers from odd numbers, you can tell what the bits in Drive 2 should be.

**TABLE 4-7** Calculating Odd Parity with RAID-5

Drive 1 Data Bit 1 [21 (2)]	Drive 2 Data Bit 0 [20 (1)]	Drive 3 Odd Parity
0	Fail	1
0	Fail	0
1	Fail	0
<b>1</b>	<b>Fail</b>	<b>1</b>

The last stripe is in bold. You can see that it has two 1s, which is an even number. The missing bit in Drive 2 must be a 1 to give the stripe an odd number of 1s. Can you fill in the bits for Drive 2 without looking back at Table 4-6?

When a drive fails in a RAID-5, the array can calculate the missing bit on the fly. That is, an entire drive can fail and the array will continue to work. It will be slower, but it will still work. However, if two drives fail, it can no longer operate.

RAID-5 doesn't write data one bit at a time. Instead, it writes the data and parity in 64-KB stripes. Also, even though it uses the equivalent of one drive for parity, parity is not contained on just one drive. A RAID-5 alternates which drive is holding the parity bits in different stripes, as shown in Figure 4-15.

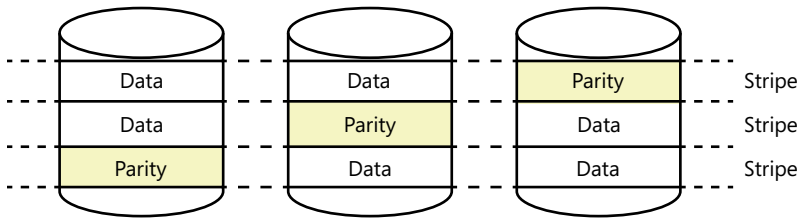

**FIGURE 4-15** Raid-5 array with three drives.

A RAID-5 array can have more drives, such as five or six, but it still devotes the equivalent of one drive for parity. If it had a total of five drives, four drives would be for data and one drive would be for parity.

## RAID 10



*RAID-10* is a combination RAID-1 (mirror) and RAID-0 (striped). It's often referred to as a *stripe of mirrors* and includes at least four disks. It's the best of the four RAID options but is more expensive. RAID-10 is often used on servers with databases.

Figure 4-16 shows an example of how this is configured. Disks 1 and 2 are a RAID-1 (mirror), and they each hold a copy of the same data. Disks 3 and 4 create another RAID-1, and they each hold a copy of the same data. Combined Array A and Array B are configured as a RAID-0 (stripe).

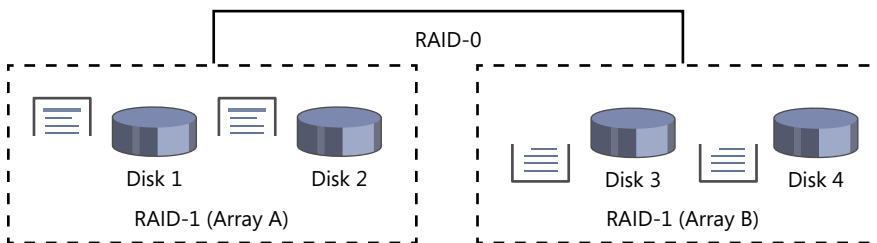

**FIGURE 4-16** Raid-10 array.

### **NOTE** ADDITIONAL MIRRORS POSSIBLE

You can create a RAID-0 array with more than just two disks. Similarly, you can create a RAID-10 with more than just two mirrors. A RAID-10 will always have an even number of disks.

Disks in the mirror labeled Array A hold half the data, and disks in the array labeled Array B hold the other half of the data. This is similar to how a two-disk RAID-0 would hold half the data on each of two disks. The RAID-10 has superior read and write performance, similar to a RAID-0, and also has fault tolerance similar to a RAID1.

Additionally, a RAID-10 can survive the failure of multiple drives. For example, if Disk 1 in Array A fails and Disk 3 in Array B fails, it can still operate because the data can be retrieved from Disks 2 and 4. However, if two disks in the same mirror fail (such as both Disk 1 and Disk 2), it's time to look for your backups.

## RAID and Backups

An important point you should understand about RAID is that it is not a replacement for backups. RAID provides fault tolerance, and backups ensure that you can restore data if the original data is lost.

For example, consider a system with a RAID-5. If one of the drives fails, the RAID-5 provides fault tolerance allowing the system to continue to operate. What if the system suffers a catastrophic failure from a power spike or fire, or what if it is stolen? Without a backup, the data is lost forever.

## Calculating Usable Storage Space in RAID

In some versions of RAID, some of the space is used for redundancy, so it isn't available for data. For example, if you have two 1-TB drives used in a mirror, you can store only 1 TB of data. The mirror holds a complete copy, so even though you have 2 TB of drive space, only 1 TB of drive space is available for data.

You should be able to identify how much usable drive space you have with different RAID configurations. Table 4-8 shows some examples of how much usable disk space you'll have if each disk is 500 GB in size.

**TABLE 4-8** Calculating Storage Space

RAID	Number of Disks	Usable Disk Space
RAID-0	Two	1 TB
RAID-0	Three	1.5 TB
RAID-1	Two	500 GB (500 GB is mirrored)
RAID-5	Three	1 TB (500 GB is used for parity)
RAID-5	Five	2 TB (500 GB is used for parity)
RAID-10	Four	1 TB (1 TB is mirrored)
RAID-10	Six	1.5 TB (1.5 TB is mirrored)



## RAID Summary

Table 4-9 compares key points for each of the RAID configurations. The Read/Write Benefits column compares the benefits of reading and writing data to the array instead of to a single disk drive.

**TABLE 4-9** RAID Array Summary

RAID	Fault Tolerance	Read/Write Benefits	Min # of Disks	Comments
RAID-0	No	Improved Read/Write	2	Use for performance only
RAID-1	Yes	Improved Read	2	Duplexing adds a second controller
RAID-5	Yes	Improved Read/Write	3	Writes are slower than RAID-0 due to parity calculations
RAID-10	Yes	Improved Read/Write	4	Best and most expensive



### Quick Check

1. Name three RAID configurations that provide fault tolerance.
2. How many disks are used in RAID-5?

### Quick Check Answers

1. RAID-1, RAID-5, and RAID-10.
2. Three or more.

## Common Symptoms

Some of the common problem symptoms of hard disk drives and RAID arrays are described in the following sections. The only hardware tool you'll need when working on hard drives is a screwdriver.

### Loud Clicking Noise

This is never a good noise to hear from a hard drive. It indicates that as the platter is spinning, it's hitting something it shouldn't. The heads are riding on an extremely thin pocket of air, and if they are jarred just the slightest bit, they can crash onto the spinning platter. This is why, when hard drives fail, technicians often refer to it as a hard drive crash.

If you hear a clicking noise coming from a hard drive, back up the data as quickly as possible and replace it. It's just a matter of time before it fails.

#### **REAL WORLD AS A LAST RESORT, TRY THE FREEZER TRICK**

I once had a drive that started giving some random errors and then started making all sorts of clicks that you just don't want to hear out of a hard drive. I powered it down to let it rest and then came back the next day to back up the data. The symptoms returned almost immediately. I needed to try something different.

I powered down the system, removed the hard drive, sealed it in a plastic bag, and stored it in a freezer overnight. It's an old trick I'd heard about but never tried before. I put it back into the system the next day and powered it up. Thankfully, it worked long enough for me to get my data back. Cold causes objects to contract, and while the drive was cool, it was running without problems. As soon as it started heating up, the problems returned, but by then I had my data. You don't want to try the freezer technique as the first step, but it might be useful as a last-ditch effort.

## Read/Write Failure

When clusters on a hard drive fail, a hard drive is unable to read or write data to the cluster. Whenever you see errors related to hard disk reads and writes, it's safe to assume that there are problems with clusters on the drive. These are relatively easy to overcome on Windows-based systems, using simple tools such as `chkdsk` and Check Disk. Both of these tools are presented in Chapter 16.



#### **EXAM TIP**

Chapter 16 also covers formatting a disk. You usually have the option of doing a full format or a quick format. A full format checks disk clusters and marks faulty clusters as bad so that they won't be used. A quick format does not check the clusters. It's always a good idea to do a full format when putting a new disk into service.

## Slow Performance

The most common reason for a hard drive's performance to slow down is fragmentation. Ideally, files are written in contiguous clusters, but as the drive is heavily used or fills up, there aren't as many contiguous clusters available. Instead, a file is divided into multiple fragments on clusters scattered throughout the disk.

When too many files are fragmented, the drive appears slower because it's having to work harder and harder to retrieve all the file fragments. Again, the solution is simple if you know

what tools to use. Chapter 16 covers the defrag and Disk Defragmenter tools that can check a disk for excessive fragmentation and that can defragment drives when they need it.



#### **NOTE DISK THRASHING**

*Disk thrashing* indicates that the hard drive is constantly working. You can often hear the constant movement of the actuator arm and see that the disk LED is constantly blinking. This is often an indication that the disk is fragmented. Alternatively, it might indicate that the system doesn't have enough memory, but you should check for fragmentation first.

## Failure to Boot or Operating System Not Found

If the system won't boot at all or gives an error indicating that it can't find the operating system, it could be that the bootable drive failed. If so, you'll need to replace it and rebuild the system. However, you should check the basics first.

The most common reason is that the system is trying to boot to a device that does not have a bootable operating system. If the system has floppy or optical drives, remove any disks/discs and then try to reboot. You might also need to check the BIOS to ensure that the system is configured to boot from the hard drive.

If you see this problem after a system was recently worked on or a drive was replaced, double-check the cabling and jumpers. It's very likely you'll find the problem.

If the system is using a RAID-1 and the first drive in the array fails, you might need to reconfigure the system to use the second drive. Some RAIDs will automatically boot to the alternate drive, but occasionally you'll need to manually reconfigure the disks. For example, you might need to swap the wiring or jumpers for the two disks in the array so that the good drive is recognized as the first drive.

## RAID Not Found

Hardware RAID systems often come as external RAID enclosures, and when you first hook them up to a system, they might not be recognized. The most common reason is that the operating system doesn't have the drivers needed to use it.

In this case, the solution is simple. Locate the drivers and install them. For new RAID systems, the manufacturer will include drivers. Follow the instructions that came with the device to install them. If it's not a new system, you can usually download the correct drivers from the manufacturer's website.

#### **MORE INFO CHAPTER 15, "CONFIGURING WINDOWS OPERATING SYSTEMS"**

Chapter 15 covers device drivers in more depth, including the use of tools such as Device Manager to install new drivers.

## RAID Stops Working

If a RAID-0 has a failure in any single drive, it will stop working completely. You'll need to replace the drive, rebuild the array, and restore the data from a backup.

However, other RAID arrays have built-in redundancy, so you usually won't see this symptom unless more than one drive fails. For example, if you have a RAID-5 array with five disks and two disks fail, the RAID-5 will stop working completely. In this case, the solution is the same as with a RAID-0. Replace the drives, rebuild the array, and restore the data from a backup.

This brings up an important point. When you see errors starting to appear in a RAID array, fix them immediately. A technician who sees a failed drive in a RAID-5 array might say, "I'll fix that tomorrow." However, if a second drive fails, it's too late.

## BSOD

It isn't common to have a stop error or blue screen of death (BSOD) from a hard drive or RAID problem. If it occurs, the most common reason is because the operating system doesn't have the correct driver for the drive. The most common solution is to boot into Safe Mode and install the correct driver.

### **MORE INFO** CHAPTER 17, "TROUBLESHOOTING WINDOWS OPERATING SYSTEMS"

Chapter 17 covers Safe Mode, including how to access it and the tools that are available.



### **Quick Check**

1. What tool can you use if a drive gives read/write failure errors?
2. What tool can you use to check a disk if it is slow?

### **Quick Check Answers**

1. Check Disk or chkdsk.
2. Disk Defragmenter or defrag.

## Chapter Summary

---

- Hard disk drives include platters, read/write heads, and actuator arms. Data is written onto ferromagnetic material on the platters. Platters spin at rates such as 5400, 7200, 10,000, and 15,000 revolutions per minute (rpm).
- IDE (or PATA) interfaces are being replaced by SATA interfaces. Most motherboards include two IDE connectors, and each connector supports two drives. You need to configure jumpers, selecting master, slave, or cable select.
- PATA drives use 80-wire, 40-pin ribbon cables for data. 4-pin Molex power connectors provide 5 V and 12 V. ATA-7 (UDMA/133) can transfer data at a rate of 133 MBps.
- Motherboards have a single connector for each SATA drive. SATA connectors have a distinctive L shape. Data cables include seven wires. Power cables have five wires, providing 3.3 V, 5 V, and 12 V, but the power connector has 15 pins.
- SATA speeds are as follows: SATA 1.5G 150 MBps (1.5 Gbit/s), SATA 3G 300 MBps (3 Gbit/s), and SATA 6G 600 MBps (6 Gbit/s).
- SATA data connectors use a 7-pin L-shaped connector, and power connectors use a 15-pin L-shaped connector.
- External drives can be connected to a computer with USB, FireWire, and eSATA connections. Many eSATA connectors on laptops use combo eSATA and USB ports.
- Some common SCSI speeds are as follows: Ultra-160 160 MBps (1.28 Gbit/s), Ultra-320 320 MBps (2.56 Gbit/s), and Ultra-640 640 MBps (5.12 Gbit/s). SCSI devices use 25-pin, 50-pin, 68-pin, or 80-pin ribbon cables.
- A single SCSI controller supports as many as 15 devices identified with a device ID. The controller is normally assigned ID 7, which has the highest priority.
- SSDs have no moving parts but instead are nonvolatile RAM used as a drive. They are much quicker than hard disk drives but also more expensive.
- Digital cameras and recorders use a similar type of portable memory. Common brands are CompactFlash, Secure Digital, mini-SD, and micro-SD.
- Optical disk capacities are as follows: CD 700 MB, mini-CD 194 MB, DVD 4.7 GB, dual-layer DVD 8.5 GB, single-layer Blu-Ray 25 GB, and dual-layer Blu-Ray 50 GB.
- Optical discs designated with R are recordable, indicating data can be written to them once. RW indicates rewritable, and data can be written to the disc many times. Blu-Ray RE discs are recordable and erasable.
- Combo drives can read and write data to multiple types of optical discs, including CDs, DVDs, and Blu-Ray discs.
- Tape drives can be used for backups but are rarely used on desktop computers. Floppy drives support 3.5-inch 1.44-MB drives but are rarely included with computers today.

- RAID configurations provide different benefits by combining multiple disks. RAID-0 does not provide fault tolerance, but RAID-1, RAID-5, and RAID-10 do provide fault tolerance.
- Hardware RAID is more efficient than software RAID. Ensure that you have the correct drivers for a hardware RAID enclosure.
- Clicking noises from a hard drive indicate a hard drive crash. Back up data as soon as possible.
- Use tools such as chkdsk, Check Disk, defrag, and Disk Defragmenter to maintain drives.

## Chapter Review

---

Use the following questions to test your knowledge of the information in this chapter. The answers to these questions, and the explanations of why each answer choice is correct or incorrect, are located in the “Answers” section at the end of this chapter.

1. You are adding an internal SATA drive to an existing system. How many drives can you connect to a SATA connector?
  - A. One
  - B. Two
  - C. Three
  - D. Four
2. What type of data connector is used for a SATA 3G drive?
  - A. 40-pin, 40-wire ribbon cable
  - B. 40-pin, 80-wire ribbon cable
  - C. 7 pins with an L-shaped connector
  - D. 15 pins with an L-shaped connector
3. Which of the following is not a valid external connector for a hard drive?
  - A. USB
  - B. FireWire
  - C. eSATA
  - D. 1934b

4. How much data can you store on a DL DVD disc?
  - A. 700 MB
  - B. 4.7 GB
  - C. 8.5 GB
  - D. 17.1 GB
  
5. What is the minimum number of drives in a RAID-1?
  - A. One
  - B. Two
  - C. Three
  - D. Four
  
6. You hear a hard drive making loud clicking noises. What does this indicate?
  - A. Failing hard drive
  - B. Normal operation
  - C. Disk thrashing
  - D. Bad clusters

# Answers

---

1. **Correct Answer:** A
  - A. **Correct:** SATA connectors support only one drive.
  - B. **Incorrect:** IDE connectors support two drives.
  - C. **Incorrect:** None of the interfaces support three drives.
  - D. **Incorrect:** A single motherboard includes two IDE drives and can support four SATA drives.
  
2. **Correct Answer:** C
  - A. **Incorrect:** Older PATA drives use 40-pin, 40-wire cables.
  - B. **Incorrect:** Newer PATA drives use 40-pin, 80-wire cables.
  - C. **Correct:** SATA data connectors use a 7-pin *L*-shaped connector.
  - D. **Incorrect:** SATA power uses a 15-pin *L*-shaped connector.
  
3. **Correct Answer:** D
  - A. **Incorrect:** USB connectors can be used to connect drives.
  - B. **Incorrect:** FireWire connectors can be used to connect drives.
  - C. **Incorrect:** Hard disk drives can be connected with eSATA.
  - D. **Correct:** 1394a and 1394B are FireWire 400 and FireWire 800, but an external connector named 1934b doesn't exist.
  
4. **Correct Answer:** C
  - A. **Incorrect:** A standard CD holds 700 MB.
  - B. **Incorrect:** A single-layer DVD holds 4.7 GB.
  - C. **Correct:** A dual-layer DVD holds 8.5 GB.
  - D. **Incorrect:** A dual-layer double-sided DVD holds 17.1 GB.
  
5. **Correct Answer:** B
  - A. **Incorrect:** None of the RAID configurations use one drive.
  - B. **Correct:** RAID-1 (mirror) uses only two drives.
  - C. **Incorrect:** RAID-5 requires a minimum of three drives.
  - D. **Incorrect:** RAID-10 requires a minimum of four drives.



**6. Correct Answer: A**

- A. Correct:** This indicates a failing hard disk drive.
- B. Incorrect:** Clicking noises from a hard disk drive are not normal.
- C. Incorrect:** Disk thrashing is when you can hear the actuator busily working and see the LED constantly blinking.
- D. Incorrect:** Bad clusters will give read and write errors.

